

PICO Projector

User Manual

The color and the appearance of the product may differ from the illustrations in this manual. The specifications are subject to change without prior notice to improve performance.



Table Of Contents

MAJOR SAFETY PRECAUTIONS

Before You Start	1-1
Care and Maintenance	1-2
Safety Precautions	1-3

INSTALLATION AND CONNECTION

Package Contents	2-1
Connecting and Disconnecting the Battery	2-2
Zoom and Focus Adjustment	2-3
Screen Size and Projection Distance	2-4
Ventilation openings	2-5
Supported Display Modes	2-6
Ports	2-7
Connecting with a PC and Setting up the PC	2-8
Connecting to an AV Device	2-9
Connecting an External Speaker	2-10
Connecting the Power and Charging the battery	2-11
Connecting to an External Memory Device and USB Cable	2-12

USING

Product Features	3-1
Product Details	3-2
LED Indications	3-3
Using the Screen Adjustment Menu (OSD: On Screen Display)	3-4
Supported File Formats	3-5
Firmware Update	3-6

TROUBLESHOOTING

Before Requesting Service	4-1
---------------------------------	-----



MORE INFORMATION

Specifications	5-1
Contact SAMSUNG WORLDWIDE	5-2
Correct Disposal - Europe only	5-3

1 Major Safety Precautions

1-1 Before You Start

Icons used in this manual

ICON	NAME	MEANING
	Caution	Indicates cases where the function may not work or the setting may be canceled.
	Note	Indicates a hint or tip to operate a function.

Using this Manual

The contents of this manual are subject to change without prior notice for performance improvement.

- Make yourself fully aware of the safety precautions before using this product.
- If a problem occurs, refer to the 'Troubleshooting' section.

Copyright Notice

Copyright © 2010 Samsung Electronics Co., Ltd. All rights reserved.

The copyright of this manual is reserved by Samsung Electronics, Co., Ltd.

The contents of this manual may not be partially or in whole reproduced, distributed or used in any form without the written permission of Samsung Electronics, Co., Ltd.

An administration fee may be charged if either.

(a) An engineer is called out at your request and there is no defect in the product.

(i.e. where you have failed to read this user manual).

(b) You bring the unit to a repair centre and there is no defect in the product.

(i.e. where you have failed to read this user manual).

The amount of such administration charge will be advised to you before any work or home visit is carried out.

1-2 Care and Maintenance

Cleaning the Surface and the Lens

Clean the projector using a soft dry cloth.

- Avoid cleaning the product with a flammable substance such as benzene or thinner.
- Avoid scratching the lens with your fingernails or a sharp object. This may result in scratches or damage to the product.
- Avoid cleaning the body of the product with a wet cloth or by directly spraying water onto the product. If water enters the product, it may result in fire, electric shock, or a problem with the product.
- A white stain may appear on the surface of the projector if water gets on it.

 The appearance and the color may differ depending on models.

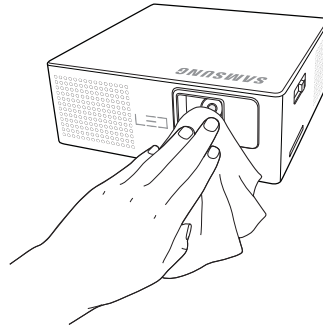

Cleaning Inside the Projector



For cleaning the interior of the projector, contact an authorized Samsung Service Center.

- Contact a Service Center if dust or other substances are inside the projector.



1-3 Safety Precautions

Icons used for safety precautions

ICON	NAME	MEANING
	Warning	Failing to follow the precautions marked with this sign may result in a serious injury or even a fatality.
	Caution	Failing to follow the precautions marked with this sign may result in a personal injury or property damage.

Meaning of Signs



Do not perform.



Must be followed.

Power Related

 The following images are for your reference and may differ depending on models and countries.
The appearance and the color may differ depending on models.

Warning



Avoid plugging in or unplugging the power supply with wet hands.

- Otherwise, it may result in electric shock.



Keep the power cord and the product away from heaters.

- Otherwise, it may result in electric shock or fire.

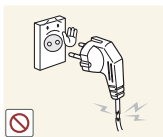

Avoid using a damaged power cord or plug or a loose power outlet.

- Otherwise, it may result in electric shock or fire.

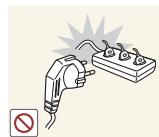

Avoid connecting multiple electric appliances to a single wall outlet.

- Otherwise, it may result in fire due to overheating of the wall outlet.

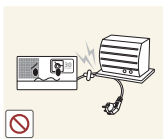

Avoid bending or twisting the power cord excessively and avoid placing heavy objects on the cord.

- Otherwise, it may result in electric shock or fire due to a damaged power cord.



If the power plug pin or jack is exposed to dust, water or alien substances, clean it thoroughly.

- There is a danger of electric shock or fire.

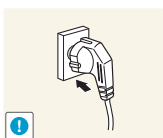

Plug the power plug in firmly.

- Otherwise, it may result in fire.

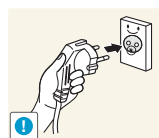

Make sure to connect the power cord to a grounded wall outlet (for insulation class 1 equipment only).

- Otherwise, it may result in electric shock or injury.



Precautions for handling the battery.

- Do not use an unapproved battery. It may explode.
- Do not apply a strong force to the battery or attempt to make a hole in the battery.
- Neither heat the battery nor store it in a place with a high temperature, such as a car interior in the summer.
- Do not let the battery get wet.
- Do not let your child or pet suck or hold the battery in his mouth.
- Do not let the charging terminal of the battery contact any metal object.

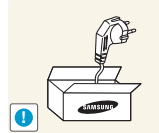

Make sure to use only the power cord supplied by our company. In addition, do not use the power cord of another electric appliance.

- Otherwise, it may result in electric shock or fire.

Caution

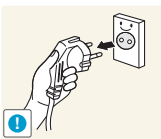

When unplugging the power plug from the wall outlet, make sure to pull the power plug and not the cord.

- Failing to do so may result in electric shock or fire.

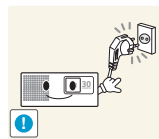

If a problem occurs with the projector when the battery is removed, be sure to remove the power plug to cut off the power supply completely. The power button alone will not cut off the power supply completely.

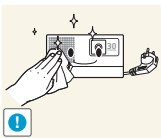

Unplug the power plug before cleaning the product.

- There is a danger of electric shock or fire.

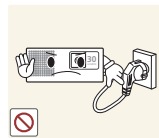

When the battery is removed, do not attempt to turn the projector on or off by connecting or removing the power plug. (Do not use the power plug as a power switch.)

Installation Related

Warning

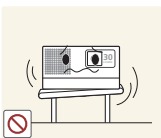

When installing the product on a console or shelf, make sure that the front of the product does not protrude out of the console or shelf.

- Otherwise, this may cause the product to fall off and result in a malfunction or injury.



Avoid installing the product in a location exposed to direct sunlight and installing the product near a heat source such as a fire or heater.

- This may shorten the product life cycle or cause fire.

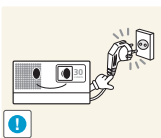

Be sure to remove the power plug and cables connected to other devices before you move the projector.

- Otherwise, it may result in electric shock or fire due to the damaged power cord.



Keep the power cord away from heaters.

- The coating of the power cord may melt and cause electric shock or fire.

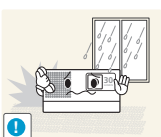

Avoid installing the product in a location exposed to dust, moisture (sauna), oil, smoke or water (rain drops) and installing it within a vehicle.

- This may result in electric shock or fire.

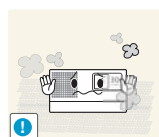

Do not install the product in areas with heavy dust.

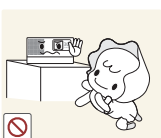

Do not install the product at a height where children may reach it.

- If a child touches the product, the product may fall and this may result in injury.

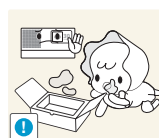

Keep the plastic bags used to pack the product away from children.

- If children place the plastic bags over their heads, they may suffocate.



If the product is installed in a location where the operating conditions vary considerably, a serious quality problem may occur due to the surrounding environment. In this case, install the product only after consulting our Call Center.

- Places exposed to microscopic dust, chemicals, too high or low temperature, high humidity, such as airports or stations where the product is continuously used for a long time etc.



Do not install the projector in a small, poorly ventilated area.

- Otherwise, a fire may result after a rise in internal temperature.

Caution

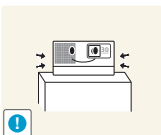

When installing the product on a console or shelf, make sure that the front of the product does not protrude out of the console or shelf.

- Otherwise, this may cause the product to fall off and result in a malfunction or injury.
- Make sure to use a cabinet or shelf suitable to the size of the product.

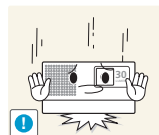

When putting the product down, handle it gently.

- Otherwise, it may result in a problem with the product or injury

Usage Related

Warning

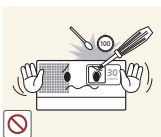

Avoid inserting metal objects such as a paper clips, coins, or hairpins, or inflammable objects into the product (the vents, ports, etc).

- If water or an alien substance enters the product, turn the power off, unplug the power cord and contact a service center.
- Otherwise, it may result in a problem with the product, electric shock or fire.

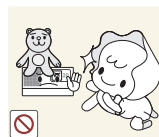

Avoid placing objects such as toys and cookies on top of the product.

- If a child hangs over the product to grab an object, the object or the product may fall and this may result in injury or even death.



Since a high voltage runs through the product, never disassemble, repair, or modify the product yourself.

- Otherwise, it may result in fire or electric shock.
- If the product needs to be fixed, contact a service center.



Do not look into the lens while the projector is on.

- This is dangerous, especially for children.

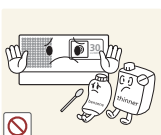

Avoid using or placing inflammable spray or objects near the product.

- This may result in an explosion or fire.



Do not attempt to insert a conductive object, such as a steel paper clips, into the power cord socket if the cord is connected to a power outlet.

Do not touch the power plug right after it was removed from the power outlet.

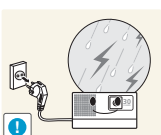

When thunder or lightning occurs, unplug the power cord.

- Failing to do so may result in electric shock or fire.



Take care not to block the vent with a table cloth or curtain.

- Otherwise, it may result in fire due to internal overheating.

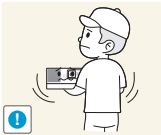

Do not let the product drop while moving it.

- This may result in a problem with the product or injury.

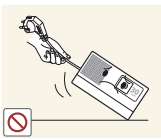

Avoid lifting up or moving the product by holding only the power cord or signal cable.

- Otherwise, it may result in electric shock, fire or a problem with the product due to damage to the cable.

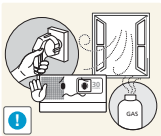

If a gas leak occurs, do not touch the product or the power plug and ventilate the area immediately.

- A spark may result in an explosion or fire.
- During a thunder or lightning storm, do not touch the power cord or antenna cable.

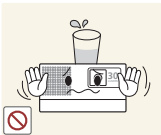

Avoid placing a container with liquid such as a vase, flowerpot, beverage can, cosmetics bottle, etc., or a metal object on the product.

- If water or an alien substance enters the product, turn the power off, unplug the power cord and contact a service center.
- Otherwise, it may result in a problem with the product, electric shock or fire.

Caution



Avoid placing a heavy object on the product.

- Otherwise, it may result in a problem with the product or injury.

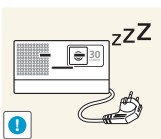

When not using the product for a long time - for example, when you go on vacation - unplug the power cord from the wall outlet.

- Otherwise, it may cause dust accumulation and result in fire caused by overheating or short circuit or result in an electric shock.



Be sure to place the projector on a table.

- Otherwise, you may trip over the projector and hurt yourself, or damage the projector.



Keep small accessories away from the children.



If you drop the product or the case is damaged, turn the power off and unplug the power cord. Contact a service center.

- Otherwise, it may result in fire or electric shock.



Avoid using a humidifier or cooker near the product.

- Otherwise, it may result in electric shock or fire.

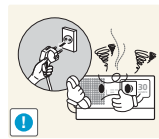

If the product generates a strange noise, a burning smell, or smoke, unplug the power plug immediately and contact a service center.

- Failing to do so may result in electric shock or fire.



Avoid dropping an object on the product or causing the product to strike or be struck by another object.

- Otherwise, it may result in electric shock or fire.



If water or any other foreign substance gets in the projector, switch the projector off, remove the power cable, and contact a service center.



Do not use the product when it indicates a malfunction, such as no sound or no picture.

- Turn the product off immediately, unplug the power cord from a wall outlet, and contact a Service Center.

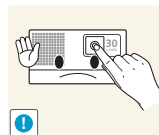

Do not touch the lens on the product.

- This may cause damage to the lens.

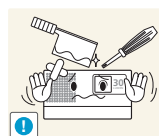

Do not touch any outer part of the product with tools such as a knife or a hammer.

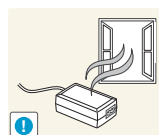

Always keep the power adaptor in a well-ventilated area.



Do not expose the adaptor to water. Do not let the adaptor to get wet.

- Water can cause a malfunction, electric shock or fire. Do not use adaptor by the waterside or outside particularly when it rains or snows. Do not let the adaptor to get wet when you clean the floor with water.

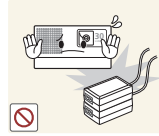

Do not place the adapter on top of another adapter.

- It may result in fire.

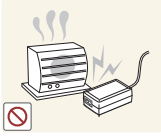

Keep power adaptor away from any other heat source.

- Otherwise, it may result in fire.

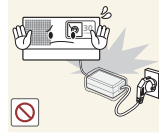

Remove the vinyl cover of the adapter before using the adaptor.

- Otherwise, it may result in fire.



Do not open any cover on the product.

- This would prove hazardous because of high-voltage current inside the product.



Avoid going near the exhaust vents or lens. Both emit extreme heat when the projector is operating and immediately after the projector is turned off.

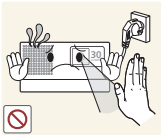

Be particularly careful not to let any of your body parts contact the exhaust vents when the projector is operating.

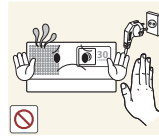

Note that the exhaust vents stay hot even after the projector is powered off.



Do not place objects vulnerable to heat near the projector.

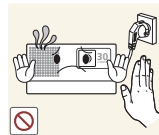

The lens may be hot. Be careful not to contact it. (Children and people with sensitive skin should be most cautious.)

Cleaning Related

Warning

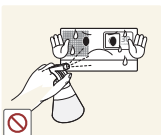

Do not clean the product case or body using water spray or a wet cloth. Avoid using any chemicals such as detergents, industrial or automotive polish, abrasive, wax, benzene, alcohol on any plastic part of the product such as projector case, since this may cause damage.



Using surfactant which contains a large amount of alcohol, solvent, or other strong chemicals may result in discoloration, cracking, or damage to the product exterior. Be sure to use the recommended cleansing agent only.

You can purchase the recommended cleansing agent from a service center.

Caution

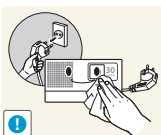

When cleaning the product, disconnect the power cord and clean the product with a soft dry cloth.

- Avoid using chemicals such as wax, benzene, alcohol, thinner, mosquito-repellent, fragrance, lubrication or cleansing agent when cleaning the product.
- This may result in the exterior being deformed or the print being removed.

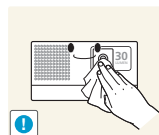

To clean dirt or stains on the front projection lens, dampen a clean cloth with a small amount of lens cleaner or a neutral detergent and water, and then rub gently.



Ask a Service Center to clean the interior of the projector at least once per year.

2 Installation and Connection

2-1 Package Contents

- Unpack the product and confirm that all of the items listed under Contents have been included.
- Store the packaging box in case you need to move the product at a later date.
- If any items are missing, contact your dealer.
- You can purchase items listed as Sold Separately from your local Samsung dealer.

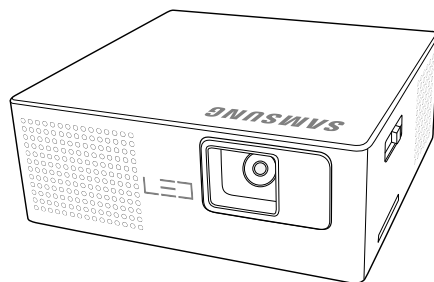

PICO Projector

CONTENTS

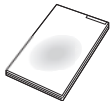

Quick Setup Guide

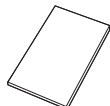

Warranty Card
(Not available in all locations)



User Manual

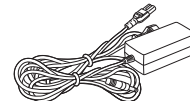

Power Cord / Adapter

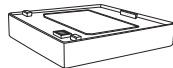

Battery

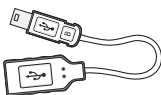

USB gender adaptor

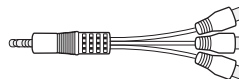

3RCA gender adaptor

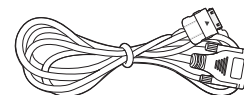

D-Sub Gender Cable

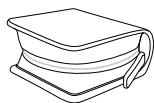

PICO Projector case

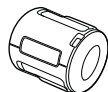

Ferrite Core for Power Cord
(1EA)

SOLD SEPARATELY

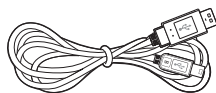

USB Cable

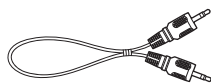

Stereo Cable

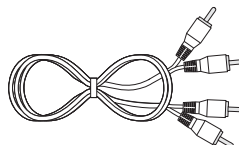

Audio Cable



Video Cable

2-2 Connecting and Disconnecting the Battery

Connecting the Battery

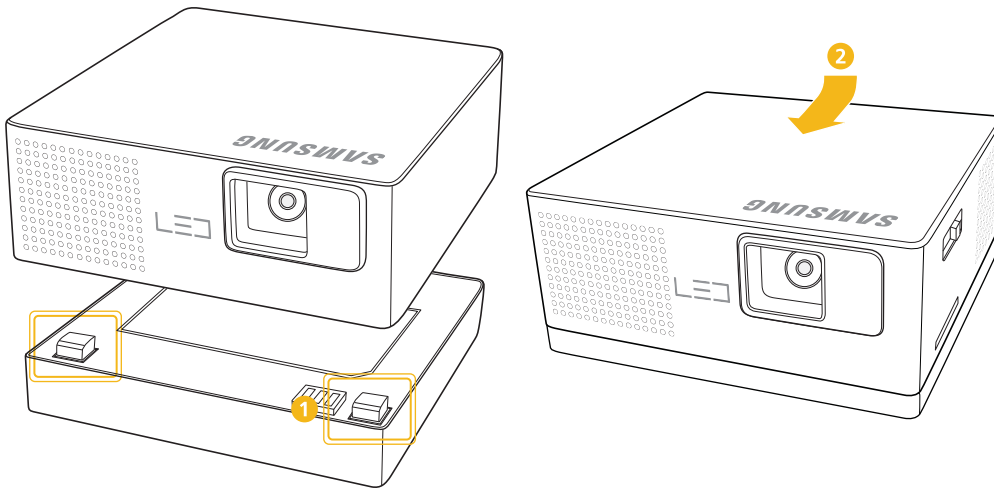

- 1 Align and fasten the grooves on the bottom of the projector with the counterparts on the battery.
- 2 Push the top and back of the projector forward simultaneously until you hear a click.

Disconnecting the Battery

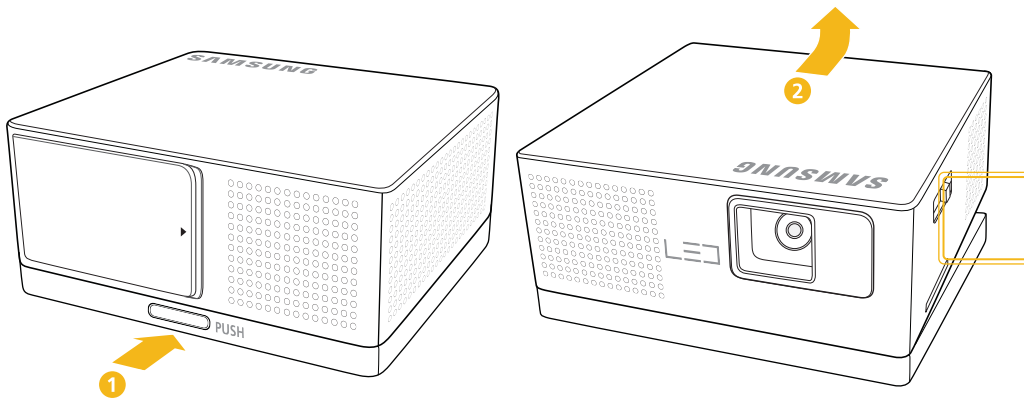

- 1 Press the lock, marked [PUSH], on the back of the battery.
- 2 With the lock held down, lift the back of the projector.

2-3 Zoom and Focus Adjustment

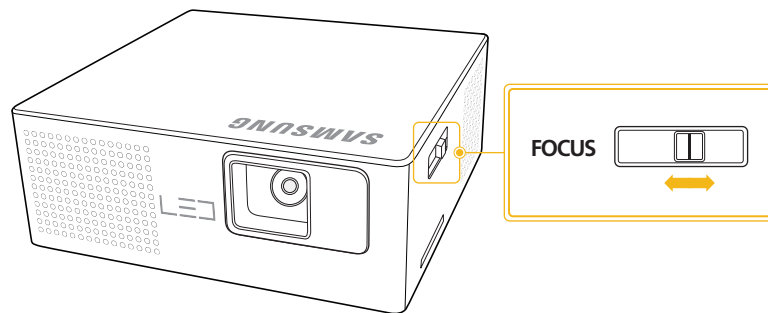

Move the **[FOCUS]** slide bar left or right until the picture is clear.

- 🔑 The size of your screen determines the distance you set your projector from the screen.
If you do not place your projector at the projection distance specified in the Screen Size and Projection Distance table in Section 2-4, you will not be able to adjust the focus correctly.

2-4 Screen Size and Projection Distance

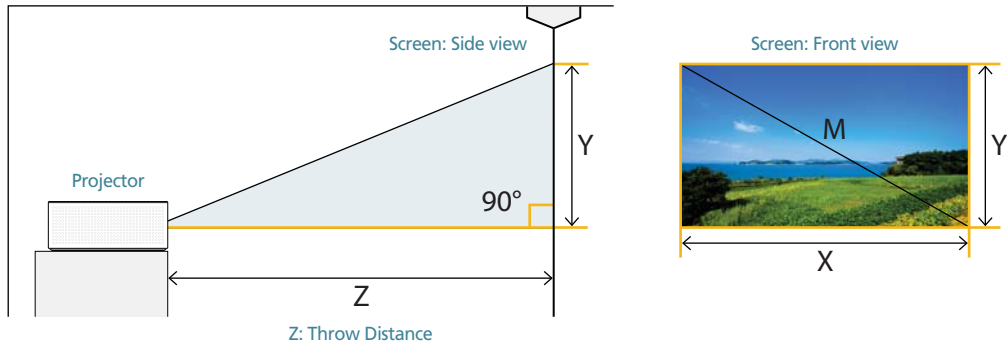

If the picture is not clear, adjust **[FOCUS]**, or move the projector forward or backward.

SCREEN SIZE						Z (THROW DISTANCE)	
M (DIAGONAL)		X (HORIZONTAL)		Y (VERTICAL)			
INCHES	CM	INCHES	CM	INCHES	CM	INCHES	CM
8.6	21.8	7.5	19.0	4.2	10.7	12.0	30.5
10	25.4	8.7	22.1	4.9	12.5	14.0	35.5
17.2	43.7	15.0	38.1	8.4	21.4	23.8	60.5
34.3	87.1	29.9	75.9	16.8	42.7	47.4	120.5
57.2	145.3	49.9	126.6	28.0	71.2	78.8	200.1
85.5	217.2	74.5	189.3	41.9	106.5	117.7	299

2-5 Ventilation openings

Ventilation openings

For the location of the ventilation openings, see the picture below:

- Do not block the ventilation openings. Blocking the ventilation openings can cause your projector to overheat and may cause it to fail.

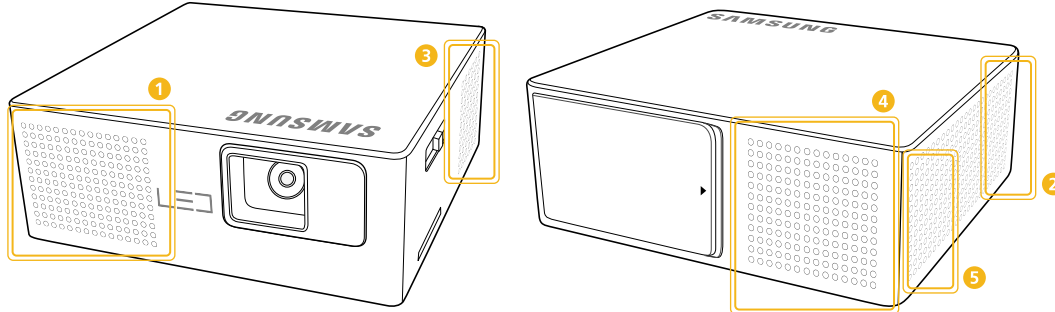

NAME		DESCRIPTION
1, 2	Exhaust vents	Air outtake vent
3, 4, 5	Intake vents	Air intake vent

2-6 Supported Display Modes

2-6-1. PC Timing (D-Sub)

FORMAT	RESOLUTION		HORIZONTAL FREQUENCY (KHZ)	VERTICAL FREQUENCY (HZ)	PIXEL FREQUENCY (MHZ)
IBM	640 x 480	60Hz	31.469	59.94	25.175
VESA	800 x 600	60Hz	37.879	60.317	40
VESA	1024 x 768	60Hz	48.363	60.004	65
VESA	720 x 576	60Hz	35.91	59.95	32.75
EIA-861B	720 x 480	60Hz	31.5	60	27.027
VESA	1280 x 800	60Hz	49.702	59.81	83.5
VESA	1280 x 768	60Hz	47.776	59.87	79.5
VESA	1280 x 720	60Hz	47.772	59.855	74.5

 All resolutions higher or lower than 854 x 480 are converted to 854 x 480 by the scaler chip in the projector. To obtain an optimal picture, the resolution from the PC should be similar to the projector (854 x 480).

2-6-2. AV Timing (VIDEO)

NTSC, NTSC 4.43, PAL, PAL60, PAL-N, PAL-M, SECAM

2-7-1. Rear View

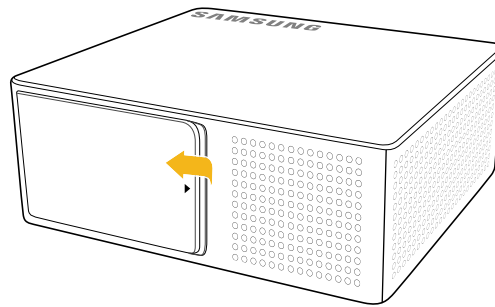

Open the cover on the back of the projector.

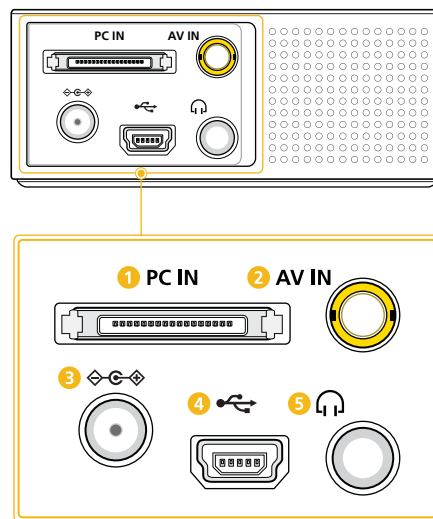

ICON	NAME
1	PC IN port
2	AV IN port
3	⏻ Power port
4	🔌 USB port
5	🔊 Audio output port

The maximum memory capacity supported for a USB memory device is 16 GB.

(The maximum capacity supported for external memory is based on our factory test. Your experience may differ depending on the manufacturer of the memory device.)

2-7-2. Side View

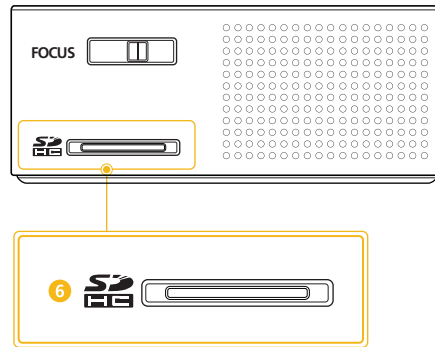

ICON	NAME
6	MicroSD(HC) card slot

-  The maximum memory capacity supported for a MicroSD(HC) card is 32 GB.
(The maximum capacity supported for external memory is based on our factory test. Your experience may differ depending on the manufacturer of the memory device.)

2-8 Connecting with a PC and Setting up the PC

2-8-1. Setting up the PC Environment

Check the following items before connecting your PC to your projector.

1. Click the right mouse button on the Windows desktop, and then click [Properties].
The <Display Properties> dialog appears.

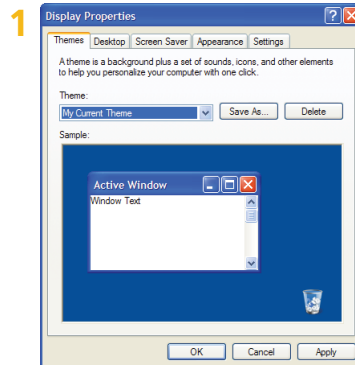

2. Click the [Settings] tab, and then set the <Screen resolution>. The optimal resolution for the projector is 800 x 600. For other resolutions supported by the projector, see the PC Timing Display Mode table in section 2-6.

 You do not have to change the <Color quality> setup.

3. Press the [Advanced] button. Another property window appears.

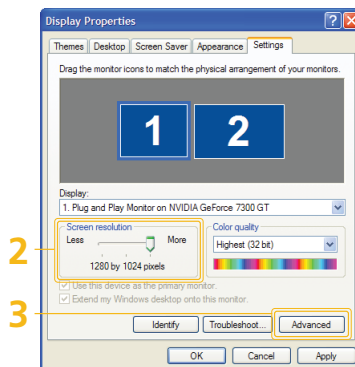

4. Click the [Monitor] tab and set the <Screen refresh rate>. For the refresh rate that matches the resolution you've chosen, see the refresh rate (60 Hz, 70 Hz, etc.) next to your selected resolution in the PC Timing Display Mode table in section 2-6.

 Setting the refresh rate sets both the vertical and horizontal frequencies.

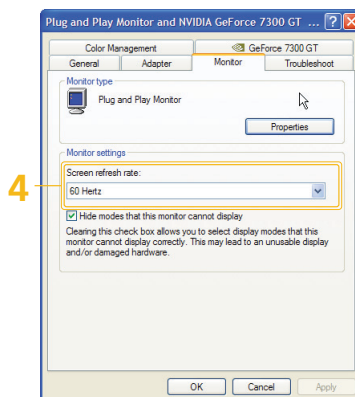

5. Click the [OK] button to close the window, and then click the [OK] button on the <Display Properties> window to close that window.
6. Shut down the PC and connect it to the projector.

- The setup process might vary depending on your type of computer or version of Windows. (For example, [Properties] appears instead of [Properties (R)] as shown in 1.)
- This projector supports 32 bit color quality (per pixel) when it is used as a PC monitor.
- Projected images may differ from the images on your monitor depending on the monitor manufacturer or Windows version.
- When connecting the projector to a PC, make sure that the PC setup complies with the display settings supported by this projector. If it does not, you may have signal problems.

2-8-2. Connecting with a PC

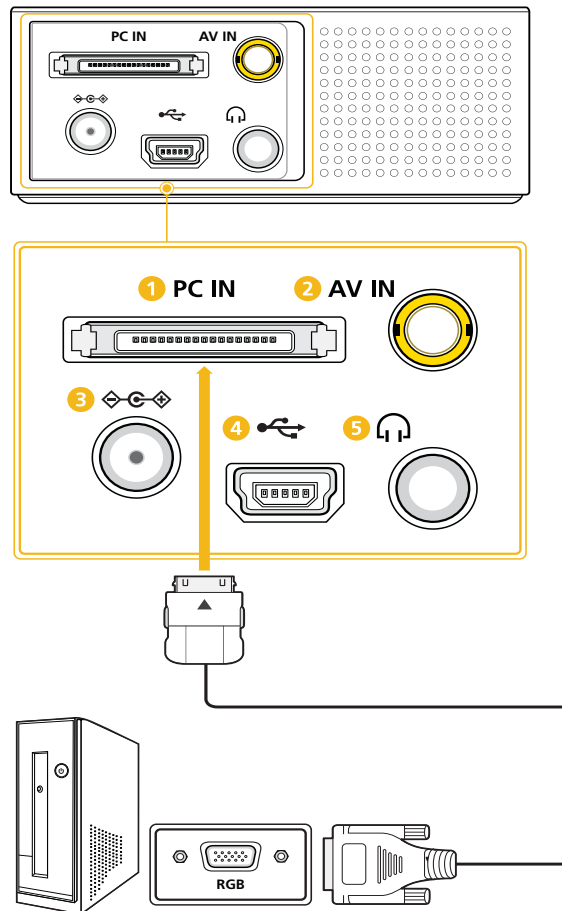

Make sure that your PC and projector are turned off.

1. Connect the D-Sub Gender Cable to **[PC IN]** on the back of the projector and RGB on the PC.
Refer to "PC Timing (D-Sub)" in the "Supported Display Modes" section for information on supported input signals.
2. Plug in the power cords of the projector and the PC.

Using the Projector

1. Turn on the projector and select <Input Source> → <PC>.
If you cannot select <PC> mode, check that the D-Sub Gender Cable is properly connected.
2. Turn on the PC, and then set the PC Environment (screen resolution, etc.) if necessary.
3. Adjust the screen.

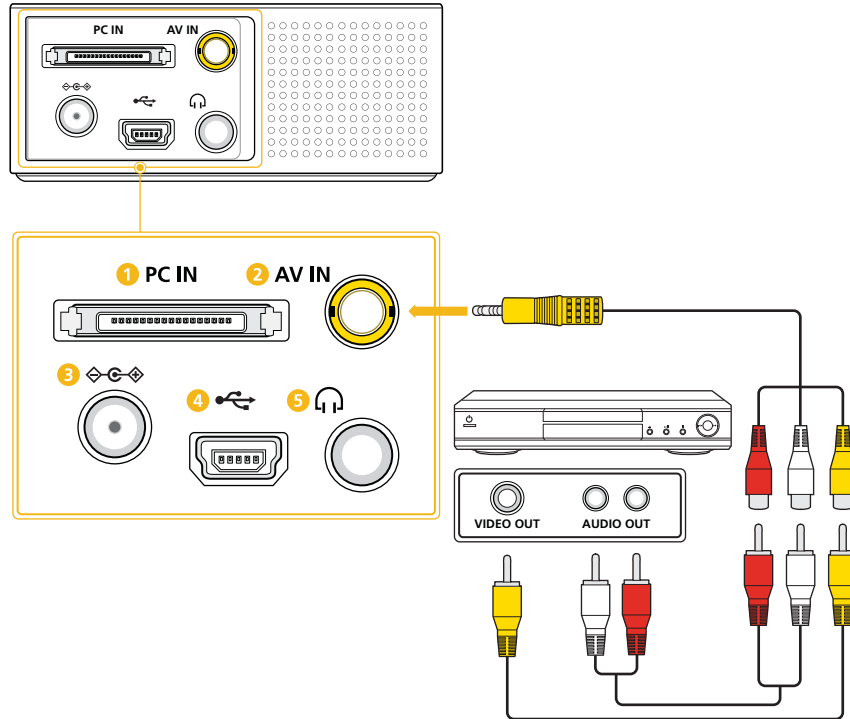

Make sure that the AV device and your projector are turned off.

1. Insert the 3RCA gender adaptor into the **[AV IN]** port on the back of the projector.
2. Connect a video cable and audio cable to the 3RCA gender adaptor.
Refer to "AV Timing (VIDEO)" in the "Supported Display Modes" section for information on supported input signals.
3. Connect the video cable to the VIDEO OUT port on the AV device.
Connect the audio cable to the AUDIO OUT port on the AV device.

 Video and audio cables are sold separately.

2-10 Connecting an External Speaker

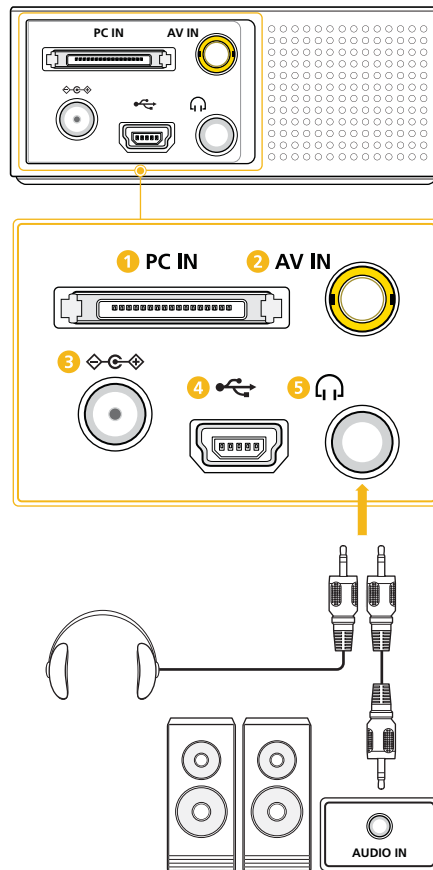

You can hear sound through an external speaker instead of the internal speakers built into the projector.

1. Connect an appropriate stereo cable to the external speaker and the [🎧] port on the projector.
 - The volume of the external speaker can be controlled by using the [^v] buttons on the projector.
 - The [🎧] port can output all of the audio input signals.

📌 Stereo cables are sold separately.

2-11 Connecting the Power and Charging the battery

2-11-1. Connecting the Power

- Be sure to connect the power supply after all other required connections are completed.

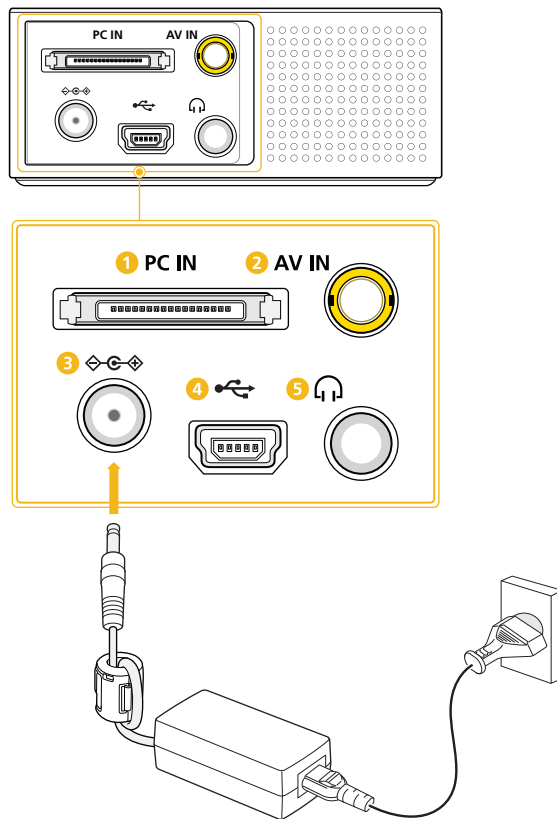

- Connect the adaptor's power cable to the [] port on the back of the projector.
- Plug one end of the adaptor's power cord to the adaptor and the other end into a wall socket.

- Ferrite Core for Power Cord**

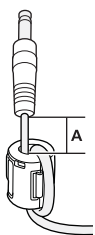



The ferrite cores are used to shield the cables from interference.

When connecting a cable, open the ferrite core and clip it around the cable near the plug as shown in the figure.

A (Distance between the ferrite core and one end of the cord put into the Projector) : below 50mm

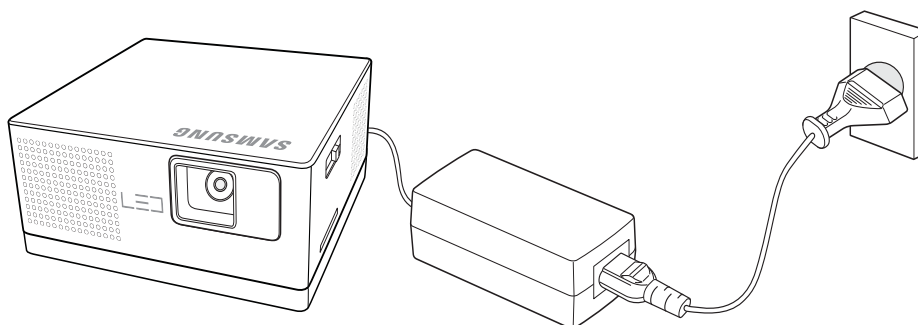
2-11-2. Charging the battery



1. Connect the battery to the projector.
 2. Make sure the projector is turned off.
 3. Connect the adaptor's power cable to the [] port on the back of the projector.
 4. Plug the adaptor's power cord into an electrical socket. The battery starts charging automatically.
- The battery is not used while the projector is connected to a wall outlet through the adaptor. (If you connect the power supply, you can use the projector when the battery is not connected.) We recommend that you keep the battery connected to the projector even when the projector is connected to a wall outlet.
 - The battery needs to be charged for about three hours if fully discharged. Do not turn on the projector when charging the battery.
 - The video playback time may differ depending on the LED mode as follows (with the battery fully charged): (The playback time may be shortened for a video played from external memory.)
<Settings> - <LED Mode> - <Normal>: Play videos for about one hour from internal memory.
<Settings> - <LED Mode> - <Eco>: Play videos for about two hours from internal memory.
 - The screen brightness may differ when the projector is operated only with the battery, depending on the remaining power.
 - The battery charge time and discharge time (time until another charge is needed) depend on the number of previous charges and the charge and usage conditions. The battery consumes power even when the device is not in use. Over time, the maximum operating time gradually shortens. (If the maximum operating time decreases by more than half, it is time to buy a new battery.)
 - The red LED (●) indicates the battery is being charged. / The blue LED (●) indicates the battery is fully charged.

2-12 Connecting to an External Memory Device and USB Cable

2-12-1. Connecting a microSD Card

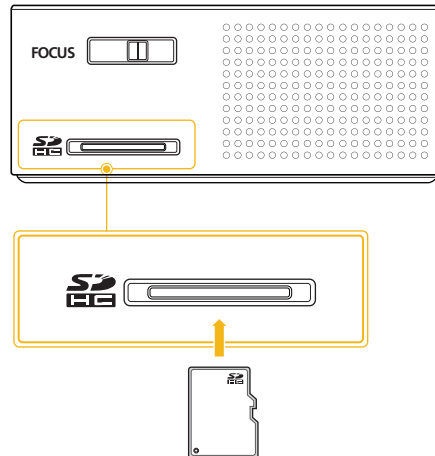



1. Insert a microSD card into the microSD card slot on the side of the projector.

 May not be compatible with some microSD cards.

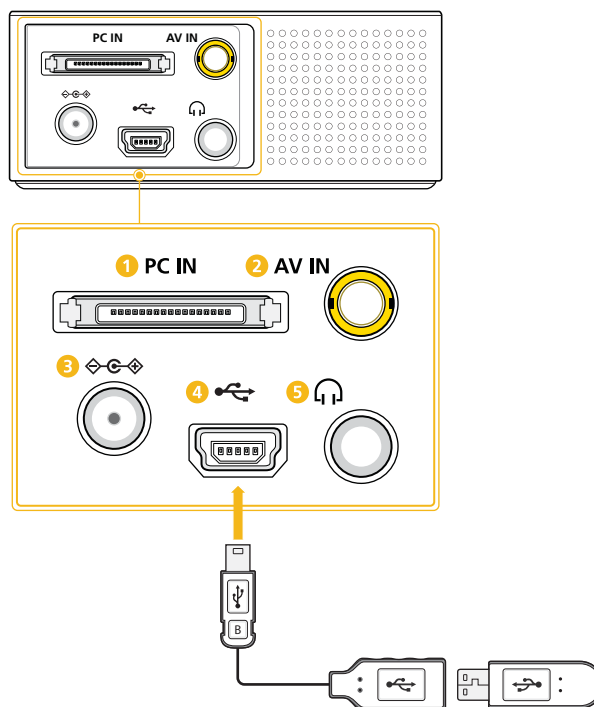
2-12-2. Connecting a USB Device



1. Connect the USB adapter to the USB device.
2. Insert the USB gender adaptor into the [] slot on the back of the projector.

-  This product does not support multi-card readers.
- This product does not work if the USB storage device is connected by a USB HUB.
- When connecting to an external hard drive, be sure that hard drive has access to a separate power supply. Otherwise, the projector may not have enough power to operate.
- Some products which do not comply with standard USB specifications might not operate normally.
- A USB storage device with an automatic recognition application or its own driver might not operate normally.
- A USB storage device that uses only a designated driver might not be recognized.

- Recognition speed for USB storage device may vary by device.
- Do not turn off the product or pull a connected USB storage device out while the USB storage device is in use. Doing so may result in damage to the USB storage device or stored file.
- Use a USB storage device which contains normal files. Abnormal files can cause a malfunction or the files may not play.
- USB storage devices must be formatted with the FAT or FAT32 (recommended) file systems supported by Windows. A memory device formatted by a program other than Windows may not work properly.
- Use the USB cable provided with the USB device when connecting it to the projector. (For more information on purchasing cable and external devices, contact the respective manufacturer.)
- Samsung shall not be held liable for any failure of an external device caused by using a cable other than the ones(s) specified for the device.
- As the data in the USB storage device can be damaged, please back up important data to avoid loss. The user is responsible for data management. Samsung shall not be held liable for any data loss.
- When using a USB storage device with the projector, subfolders with a maximum depth of 4 from the top folder are supported. Also, if the number of files (including folders) in the same folder exceeds 2,900, it will not be recognized. In addition, if there are a large number of files on a USB device, individual files may take a long time to display.
- If an external memory device does not operate after you've connected it to the projector, try to connect it to a PC. If it still does not operate normally, contact the memory device's manufacturer service center or related customer center.

2-12-3. Connecting to a PC Using a USB Cable

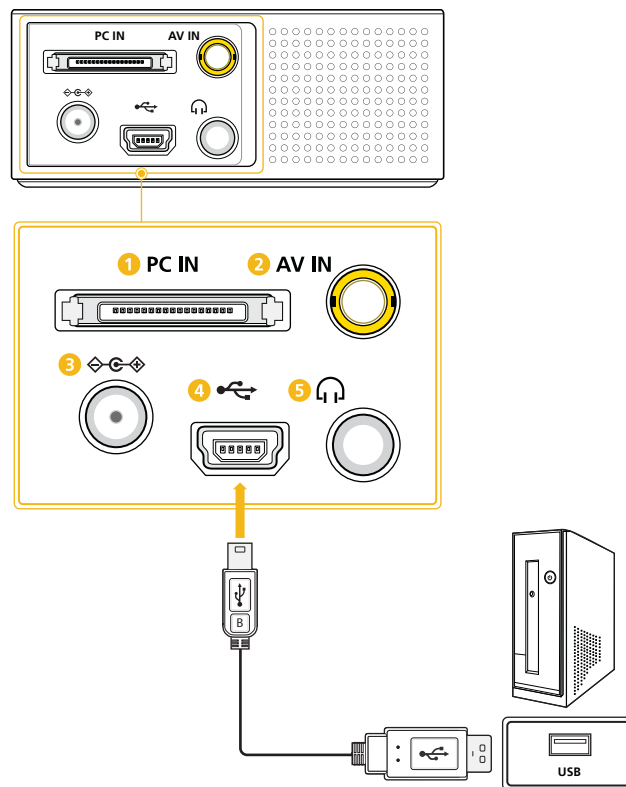

- 🔑 If you connect the projector to a PC, you can transfer files in the internal memory of the projector. Connect the smaller end of the USB cable to the projector and the larger end to the USB port of a PC.

To transfer files from a PC.

1. Make sure the projector is turned off, and then connect the projector to a PC with the USB cable.
2. Turn the projector on. The start up Samsung logo appears, then the projector displays "Loading", and then displays "Connected to PC USB port."
3. What you see next depends on your version of Windows. On many versions, the Removable Disk pop up appears on your PC screen.
If this pop up appears, select "Open folder to view files". If not, use My Computer or Windows Explorer to access the projector's files. The projector appears as a Removable Disk.
4. Transfer the files from your PC to the projector by dragging and dropping or copying and pasting.

To disconnect the projector from a PC.

Make sure to end the connection properly to prevent damage to the projector or your data.

1. Click  on the Windows Taskbar.
2. Click the pop-up message.

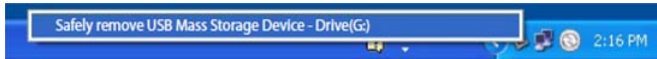

3. Disconnect the USB cable only when the message says that it is safe to remove the hardware.
 -  Do not disconnect the USB cable while the files are being copied, as this could result in loss of data or damage to the projector.
 - The connection will not end if you have projector files open on the PC. Close all projector files and try again.
 - Other versions of Windows operate similarly. Follow the correct procedure for removing a USB device from your PC safely for your version of Windows.

3 Using

3-1 Product Features

1. Advanced LED light source
 - Non-mercuric and eco-friendly, these long lasting LEDs guarantee a longer life span than traditional lamps.
2. Minimized fan noise
 - The fan noise from the projector has been minimized by optimizing the internal air circulation and fan structure.
3. Easy to carry
 - The projector is small and light, making it useful for business trips and leisure activities.
 - You can view documents, videos and photos anywhere.
4. Optical engine with DLP technologies
 - You get WVGA resolution and a bright, 30-lumens picture.
5. Various useful features
 - Multimedia player, document viewer, internal memory, microSD card slot, and a removable and rechargeable battery are included.
6. Multiple input ports
 - Multiple input ports, including PC, AV, USB, and microSD provide flexible connectivity with peripheral devices.
7. Audio output
 - Equipped with a 1 W (mono) speaker and an audio output port.
8. Convenient menu items
 - The same menu is used for all types of inputs, making the projector easy to use.

3-2-1. Product Details

The battery is disconnected.

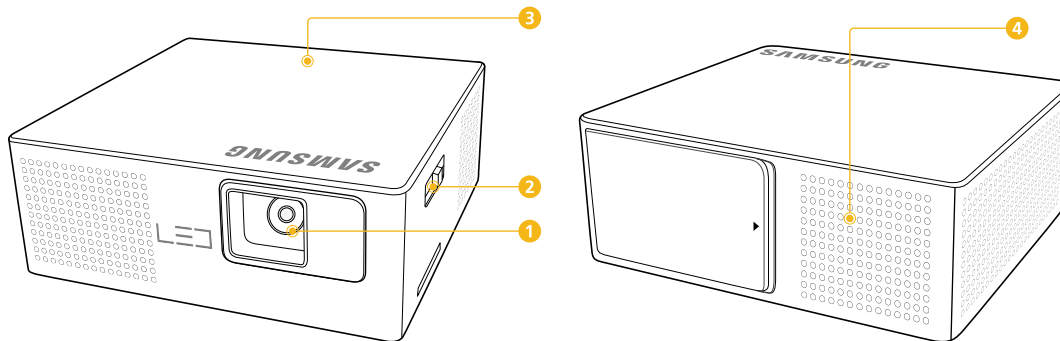

The battery is connected.

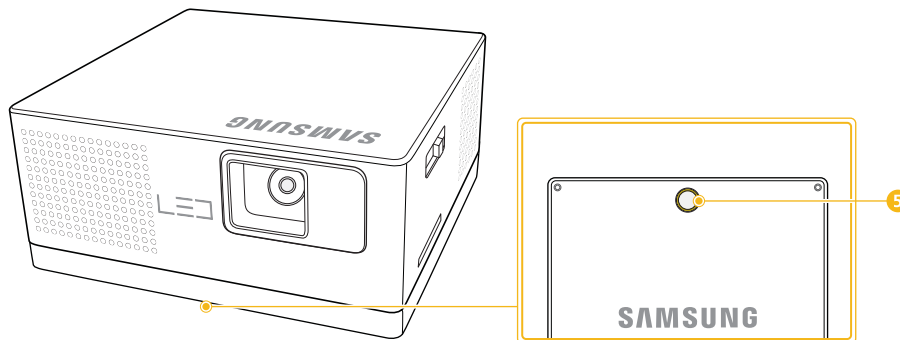

NAME		DESCRIPTION
1	Lens	Forms an image of an object on screen.
2	FOCUS	Adjusts the focus on screen.
3	Indicators	Indicates the operational status of the projector.  Refer to the “LED Indications”.
4	Speaker	Outputs sound.
5	Tripod hole	Fasten a tripod here.

Precautions for attaching the tripod

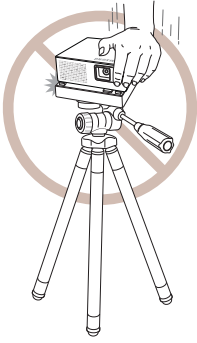

1. Do not use too much force when you attach or detach the tripod as the battery may be separated from the projector.
2. Do not forcefully connect or disconnect a cable when the tripod is attached.

3-2-2. Control Buttons

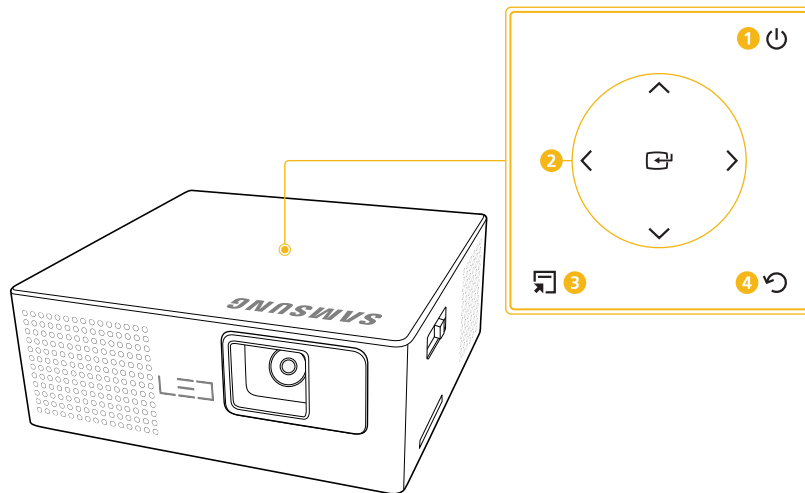

The control buttons can be found on the top of the projector.

NAME		DESCRIPTION
1	Power button	Turns the projector on or off. This button can also function as the button lock. (To enable or disable the button lock, tap this button (shorter than one second) when the projector is powered on.)
2	Direction buttons	Navigates displayed menu items and adjusts values.
	Select button	Confirms a selected function when a menu is displayed.
3	Menu button	Displays a menu.
4	Back button	Returns to the previous menu.

The [^ v] buttons can be used to control the volume during video or audio playback.

3-3 LED Indications

3-3-1. LED Indications

○ : Light is Off / ● (red) ● (blue) : Light is Blinking / ● (red) ● (blue) : Light is On

LED	STATUS
● (red)	The battery is being charged.
● (blue)	The battery is completely charged.
● (red) ● (blue)	The projector shut down automatically because it exceeded the maximum operating temperature. (The LED blinks at one second intervals.) Refer to Action 1 in Clearing Indicator Problems below.
● (red) ● (blue)	The cooling system (including the cooling fan) inside the projector is not working normally. (The LED blinks twice at one second intervals and then stays off for two seconds.) Refer to Action 2 in Clearing Indicator Problems below.
● (blue)	The LED start-up board of the projector is not working normally. Refer to Action 3 in Clearing Indicator Problems below.
● (red) ● (blue)	The battery needs to be charged.



3-3-2. Clearing Indicator Problems

CLASSIFICATION	STATE	MEASURES
Action 1	The internal temperature of the projector increased abnormally.	<ul style="list-style-type: none"> Restart the projector. If the same problem occurs continually, contact your product distributor or service center.
Action 2	The cooling system (including the cooling fan) inside the projector is not working normally.	<ul style="list-style-type: none"> Move the projector to a cool place, let it cool sufficiently, and then turn it on again. If the same problem occurs continually, contact your product distributor or service center.
Action 3	The LED start-up board in the projector is not working normally.	<ul style="list-style-type: none"> Restart the projector. If the same problem occurs continually, contact your product distributor or service center.

 This Projector uses a cooling fan system to keep the unit from overheating. Operation of the cooling fan may produce noise, This does not affect product performance and is part of normal operation.

3-4 Using the Screen Adjustment Menu (OSD: On Screen Display)

The Screen Adjustment Menu (OSD: On Screen Display) Structure

MENU	SUB-MENU				
 Input Source	PC	AV			
 Internal Memory / USB / MicroSD card	Documents	Videos	Photos	Music	Settings

3-4-1. Input Source

PC



The projector displays the signal inputted from the PC.

PC Menu

To open the PC menu window, press [

MENU	DESCRIPTION
Home	Returns to the main menu page.
Auto Adjustment	Use to adjust the frequency and phase of the PC screen automatically.
Size	Use to select a screen size. • <Normal> - <4:3>
Brightness	Use to adjust the brightness of the entire picture. Adjust from 0 to 100.
Contrast	Use to adjust the contrast between the object and the background. Adjust from 0 to 100.



The projector displays the signal inputted from the AV device.

AV Menu

To open the AV menu window, press [] when the projector is set to AV input.

MENU	DESCRIPTION
Home	Returns to the main menu page.
Size	Use to select a screen size. • <Normal> - <4:3>
Brightness	Use to adjust the brightness of the entire picture. Adjust from 0 to 100.
Contrast	Use to adjust the contrast between the object and the background. Adjust from 0 to 100.
Sharpness	Use to adjust the sharpness of the picture. Adjust from 0 to 100.
Color	Use to adjust color lighter or darker. Adjust from 0 to 100.
Tint	Use to obtain more natural color by enhancing the amount of green or red in images. Adjust from -50 to +50.  It is activated when the signal is NTSC.

3-4-2. Internal Memory / USB / MicroSD card

- The projector displays the <USB> and <MicroSD card> menus only when you have connected an external memory device (<USB>/<MicroSD card>).

Documents



You can open document files of various formats saved in the <Internal Memory>, <USB> or <MicroSD card> without conversion.







Documents Menu

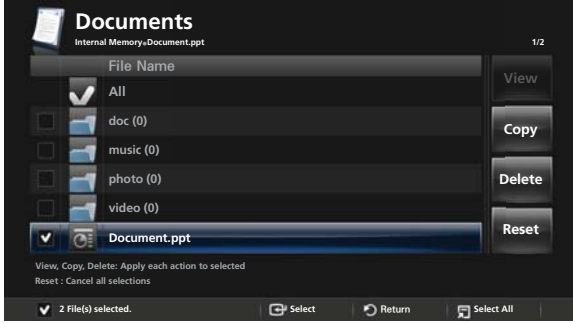

To open the Documents menu window, press [] when the projector is displaying the Document File List page.

- Depending on the current language setting, folder names, file names, or text in a document may appear corrupted. If this occurs, go to <Settings> → <General> → <Language> and change the language.

MENU	DESCRIPTION
Home	Returns to the main menu page.
Copy	Copies a document from external memory to <Internal Memory> or vice versa when an external memory device (<USB>/<MicroSD card>) is connected.
Delete	Deletes a document in <Internal Memory> or external memory (<USB>/<MicroSD card>).





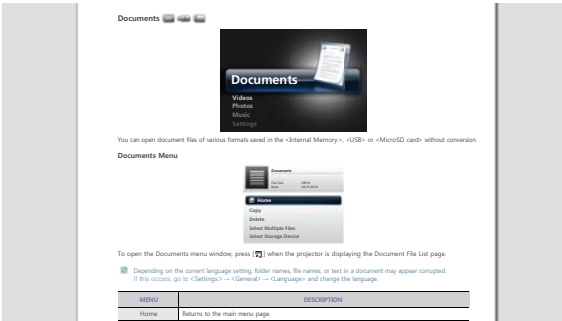

MENU	DESCRIPTION
Select Multiple Files	<p>Selects multiple document files and lets you <Copy> or <Delete> them simultaneously.</p>  <p>Move to the document file you want to select using the [^ v] buttons and tap [].</p> <ul style="list-style-type: none">  A check() mark appears next to the selected document. Tapping the [] button selects or deselects a file. To select all documents in a folder, tap []. You can select multiple documents by repeating the process above. <ul style="list-style-type: none"> <View> : Opens the selected document file. <ul style="list-style-type: none">  Enabled only when one file is selected. <Copy> : Copies multiple document files. <Delete> : Deletes multiple document files. <Reset> : Cancels all selections.
Select Storage Device	<p>Moves directly to another memory device when an external memory device (<USB>/<MicroSD card>) is connected.</p>

Document Control Menu



MENU	DESCRIPTION
Home	Returns to the main menu page



NAME	DESCRIPTION	
	View Info.	Shows the Help bar, and information regarding pages and the battery.





NAME		DESCRIPTION
	Previous/Next	^, < : Move to the previous page. <ul style="list-style-type: none">  Tapping [^] while a page is zoomed in moves the display to the top of the page. Clicking [<] while a page is zoomed in moves the display to the left side of the page.
		v, > : Move to the next page. <ul style="list-style-type: none">  Tapping [v] while a page is zoomed in moves the display to the bottom of the page. Clicking [>] while a page is zoomed in moves the display to the right side of the page.
	Button Lock	Enables or disables the button lock. <ul style="list-style-type: none">  If the button lock is enabled, all the buttons, except for [], are disabled. Press and hold the [] button to power off the projector.

Document Display Settings Menu



To open the document display settings menu window, tap [] when a document is opened.

MENU	DESCRIPTION
Home	Returns to the main menu page.
Zoom	Enlarges or reduces a document. <ul style="list-style-type: none"> <Zoom In> : Enlarge a document (25% increments within the range of 100% ~ 500%). <Zoom Out> : Reduce a document. <Custom> : Enlarge or reduce the screen by a specific percentage. <ul style="list-style-type: none"> <100%> - <200%> - <300%> - <400%> - <500%>  Range of <Zoom In> and <Zoom Out>: <100%> to <500%>
Page Navigation	Go directly to a specific page. <ul style="list-style-type: none"> Enter a page number using the [] buttons, check the page number in the preview window on the upper right corner of the screen, and then select <Go> to move to that page.
Page Map	Displays the zoom area. <ul style="list-style-type: none"> <Off> - <On>  <ul style="list-style-type: none"> The displayed area of a zoomed-in page is indicated in the <Page Map> window in the top right corner of the page. The projector displays the <Page Map> window only if you've zoomed in a page.

MENU	DESCRIPTION
Aspect Ratio	<ul style="list-style-type: none"> • <Fit to Screen> : Displays a document so that it fits the screen size. • <Original Fit> : Displays a document at its original size. • <Fit to Width> : Displays a document so that it fits the screen width. • <Fit to Height> : Displays a document so that it fits the screen height.
Rotate	<p>Rotate a document by a specified angle. Select an angle using the [< >] buttons, and tap [].</p> <ul style="list-style-type: none"> • <0°> - <90°> - <180°> - <270°> <p> Supported in PDF format only.</p>
Encoding	<p>To view a text (.TXT) file without any character corruption, you must select the original language that was used to create the file.</p> <ul style="list-style-type: none"> • <Korean> - <Central Europe> - <Cyrillic> - <Baltic> - <Greek> - <Turkish> - <Hebrew> - <Arabic> - <Latin> - <Vietnam> - <Germany> - <Français> - <Norway> - <Thai> - <Japanese> - <Simplified Chinese GBK> - <Traditional Chinese Big5> <p>(e.g.: To view a text file created in German, select <Germany>)</p> <p> • For some of the European countries whose languages are not found on the list, select <Central Europe>.</p> <ul style="list-style-type: none"> • Files created in English do not require encoding.
Videoclip	<p>Play a video file linked to a PowerPoint file (.ppt or .pptx).</p> <p> Enabled only when the linked video file is located in the same folder as the PowerPoint file (.ppt or .pptx).</p>

-  Loading time may be longer for large files.
- This product may not work properly when a file does not comply with standards or it is damaged.
- This product may not work when a file contains too much data to display on a screen. (For example, too much data on one sheet in a Excel file.)
- This product supports only one font. If a screen uses other fonts, the image Media Play displays may be different than the original screen.
For example:
 1. The position of line breaks in a sentence might be dissimilar.
 2. The position of page breaks in a MS Word document might be changed. In this case, the document might be shown incompletely according to the Layout properties for <Picture> or <Shapes> or <Object> in MS word . (Please refer to the manual of MS Word for more information on the Layout properties.)
- Some functions supported on your PC are not supported by the projector, such as these PowerPoint functions: Animation, 3D, Smart Art, Hyper Link, and Transparency and Gradation (color depth: 16 bits).
- This product does not support encrypted files (DRM).



You can enjoy video files saved in the <Internal Memory>, <USB>, or <MicroSD card>.

Videos Menu



To open the Videos menu window, tap [

-  Depending on the current language setting, folder or file names may appear corrupted. If that is the case, go to <Settings> → <General> → <Language> and change the language.

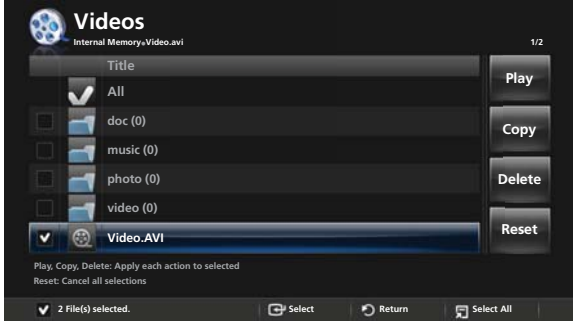

MENU	DESCRIPTION
Home	Returns to the main menu page.
Copy	Copies a video from external memory to <Internal Memory> or vice versa when an external memory device (<USB>/<MicroSD card>) is connected.
Delete	Deletes a video file in <Internal Memory> or external memory (<USB>/<MicroSD card>).

MENU	DESCRIPTION
Select Multiple Files	<p>Selects multiple video files and lets you <Play>, <Copy>, or <Delete> them simultaneously.</p>  <p>Move to the video file you want to select using the [^ v] buttons, and then tap [⇩].</p> <ul style="list-style-type: none"> • A check(✓) mark appears next to the selected video. • Tapping the [⇩] button selects or deselects a video. • To select all video files in a folder, tap [⇩]. • You can select multiple video files by repeating the process above. <ul style="list-style-type: none"> • <Play> : Plays the selected multiple video files. <ul style="list-style-type: none"> • You can select the playback order in the Video Display Settings menu. • <Copy> : Copies the selected multiple video files. • <Delete> : Deletes the selected multiple video files. • <Reset> : Cancels all selections.
Select Storage Device	Moves directly to another memory device when an external memory device (<USB>/<MicroSD card>) is connected.

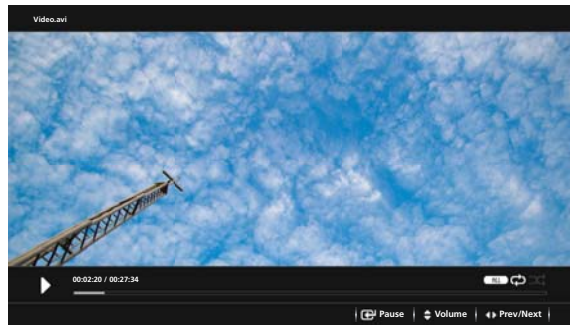
Video Control Menu



NAME		DESCRIPTION
⏮	Play/Pause	Plays or pauses a video.
▲ / ▼	Volume	Controls the volume.

NAME		DESCRIPTION
◀ / ▶	Prev/Next	◀ : Plays the previous video.  Press and hold [◀] to rewind the video (REW ◀ ◀).
		▶ : Plays the next video.  • Press and hold [▶] to fast forward the video (FF ▶ ▶). • The rewind speed increases to x2, x4, x8 and x16 at 2-second intervals.
⏻	Button Lock	Enables or disables the button lock.  • If the button lock is enabled, all the buttons, except for [⏻], are disabled. • Press and hold the [⏻] button to power off the projector.

Video Display Settings Menu

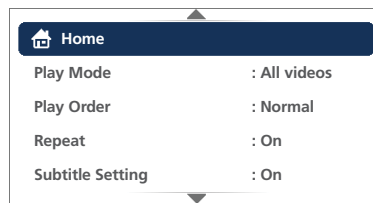

To open the video display settings menu, tap [⏻] during video playback.

MENU	DESCRIPTION
Home	Returns to the main menu page.
Play Mode	<ul style="list-style-type: none"> <All videos> :Plays all video files in file name order. <Videos in folder> : Plays all video files from a folder in file name order. <One video> : Plays only one selected video.
Play Order	Selects the playback order of videos. <ul style="list-style-type: none"> <Normal> : Plays videos in file name order. <Shuffle> : Plays videos in random order.
Repeat	Lets you select whether to play a video repeatedly. <ul style="list-style-type: none"> <Off> - <On>
Subtitle Setting	Lets you select whether to show subtitles with video playback. <ul style="list-style-type: none"> <Off> - <On>
Subtitle Language	Selects the subtitle language. <ul style="list-style-type: none"> <English> - <Deutsch> - <Nederlands> - <Español> - <Français> - <Italiano> - <Svenska> - <Português> - <Русский> - <Türkçe> - <简体中文> - <한국어>
Subtitle Background	Lets you select whether the subtitles have a background. <ul style="list-style-type: none"> <Off> - <On>
Subtitle Sync	Corrects the subtitles if they are out of synch with the video. <ul style="list-style-type: none"> <-0.5s> - <+0.5s>  Not supported for video files with internal subtitles.
Subtitle Position	Selects the position of the subtitles. <ul style="list-style-type: none"> <Up> - <Down> - <Reset>

MENU	DESCRIPTION
Subtitle Font Size	Selects the size of the subtitles. <ul style="list-style-type: none"> <Small> - <Middle> - <Large>
Subtitle Font Color	Selects a font color for the subtitles. <ul style="list-style-type: none"> <White> - <Black> - <Red> - <Green> - <Blue> - <Yellow>

- The video must have external subtitles for you to view them using the Caption feature.
- See the table for supported subtitle file types. Refer to "Supported File Formats".
- Subtitle files must be in same directory as the video file.

Photos



You can enjoy a slideshow of image files saved in the <Internal Memory>, <USB>, or <MicroSD Card>.

Photos Menu



To open the Photos menu window, tap [

- Depending on the current language setting, folder or file names may appear corrupted. If this occurs, go to <Settings> → <General> → <Language> and change the language.

MENU	DESCRIPTION
Home	Returns to the main menu page.
Copy	Copies photos from external memory to <Internal Memory> or vice versa when an external memory device (<USB>/<MicroSD card>) is connected.
Delete	Deletes photos in <Internal Memory> or external memory (<USB>/<MicroSD card>).

MENU	DESCRIPTION
Select Multiple Files	<p>Selects multiple photo files and lets you play the files in a <Slideshow>, or lets you <Copy> or <Delete> them simultaneously.</p>  <p>Move to the photo you want to select using the [^ v < >] buttons and tap [☒].</p> <ul style="list-style-type: none"> • A check(✓) mark appears in the selected photo. • Tapping the [☒] button selects or deselects a picture. • To select all the photos in a folder, tap [☐]. • You can select multiple photos by repeating the process above. <ul style="list-style-type: none"> • <Slideshow> : Plays the selected photo files in a slideshow. <ul style="list-style-type: none"> • You can select the playback order in the Slideshow Display Settings menu. • <Copy> : Copies the selected multiple photo files. • <Delete> : Deletes the selected multiple photo files. • <Reset> : Cancels all selections.
Select Storage Device	<p>Moves directly to another memory device when an external memory device (<USB>/<MicroSD card>) is connected.</p>

- To use the Photos menu in a presentation, save a general document file as an image file to an external memory device (USB memory device or microSD card).
For example, 1. Convert .ppt (Microsoft Powerpoint) files to → .jpg /.bmp /.gif
2. Convert .pdf (Adobe Acrobat) files to → .jpg
Caution: Be sure to save the image files in the order you want to present them.

Slideshow Control Menu

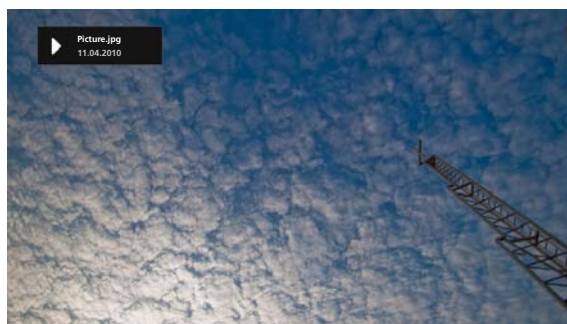

NAME		DESCRIPTION
	Play/Pause	Plays or pauses a slideshow.

NAME		DESCRIPTION
<>	Previous/Next	< : Shows the previous photo.
		> : Shows the next photo.
⏻	Button Lock	<p>Enables or disables the button lock.</p> <ul style="list-style-type: none"> • If the button lock is enabled, all the buttons, except for [⏻], are disabled. • Press and hold the [⏻] button to power off the projector.

Slideshow Display Settings Menu

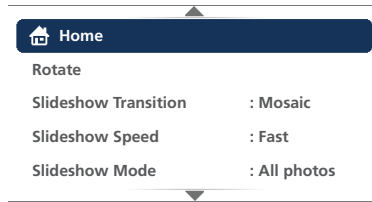

To open the Slideshow Display Settings menu, tap [⏻] during a slideshow. The slideshow pauses and the menu appears.

MENU	DESCRIPTION
Home	Returns to the main menu page.
Rotate	<p>Rotate a photo by a specified angle.</p> <p>Select an angle using the [< >] buttons, and then tap [⏻].</p> <ul style="list-style-type: none"> • <0°> - <90°> - <180°> - <270°>
Slideshow Transition	<p>Selects a photo transition effect to be inserted into a slideshow.</p> <ul style="list-style-type: none"> • <No Effect> - <Mosaic> - <Blind> - <Clock>
Slideshow Speed	<p>Selects the playback speed of a slideshow.</p> <ul style="list-style-type: none"> • <Fast> - <Normal> - <Slow>
Slideshow Mode	<ul style="list-style-type: none"> • <All photos> : Plays all image files in file name order. • <Photos in folder> : Plays all image files from a folder in file name order. • <One photo> : Plays only one selected photo.
Slideshow Order	<p>Selects the playback order of a slideshow.</p> <ul style="list-style-type: none"> • <Normal> : Plays photos in order of file name. • <Shuffle> : Plays photos in random order.
Aspect Ratio	<ul style="list-style-type: none"> • <Original Fit> : Displays a photo smaller than the screen at its original size or reduces a photo larger than the screen in direct proportion to the screen size. • <Auto Fit> : Resizes a photo to fit the screen, maintaining the original aspect ratio of the photo (The image may be cut off horizontally or vertically). • <Fit To Width> : Resizes a photo to fit the screen width. • <Fit To Screen> : Enlarges or reduces the size of a photo, regardless of the aspect ratio of the photo, to fit the full screen.

 Some functions may be limited according to the type of photo files.



You can enjoy music files saved in the <Internal Memory>, <USB> or <MicroSD card>.

Music Menu



To open the Music menu window, tap [

-  Depending on the current language setting, folder or file names may appear corrupted. If this occurs, go to <Settings> → <General> → <Language> and change the language.

MENU	DESCRIPTION
Home	Returns to the main menu page.
Copy	Copies music files from external memory to <Internal Memory> or vice versa when an external memory device (<USB>/<MicroSD card>) is connected.
Delete	Deletes music files in <Internal Memory> or external memory (<USB>/<MicroSD card>).

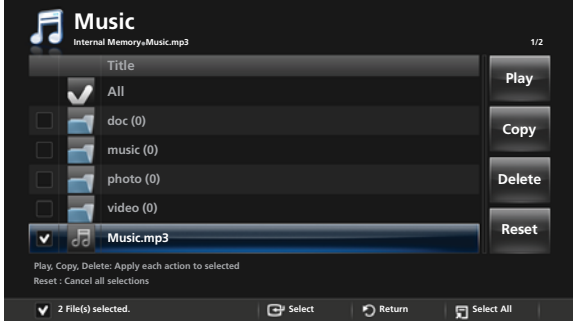
MENU	DESCRIPTION
Select Multiple Files	<p>Selects multiple music files and lets you <Play>, <Copy>, or <Delete> them simultaneously.</p>  <p>Move to the music file you want to select using the [^ v] buttons and tap [⊞].</p> <ul style="list-style-type: none"> • A check(✓) mark appears next to the selected music. • Tapping the [⊞] button selects or deselects a music file. • To select all the music files in a folder, tap [⊞]. • You can select multiple music files by repeating the process above. <ul style="list-style-type: none"> • <Play> : Plays the selected multiple music files. <ul style="list-style-type: none"> • You can select the playback order in the Music Display Settings menu. • <Copy> : Copies the selected multiple music files. • <Delete> : Deletes the selected multiple music files. • <Reset> : Cancels all selections.
Select Storage Device	Moves directly to another memory device when an external memory device (<USB>/<MicroSD card>) is connected.

Music Control Menu

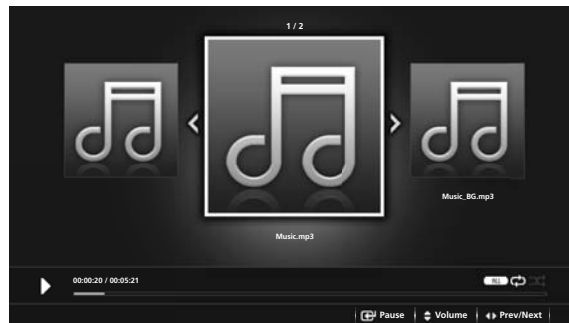

NAME	DESCRIPTION	
⏮	Play/Pause	Plays or pauses music.
▲ / ▼	Volume	Controls the volume.

NAME		DESCRIPTION
◀ / ▶	Prev/Next	<p>◀ : Plays the previous music file.</p> <ul style="list-style-type: none"> Press and hold [◀] to rewind music at 20-second intervals as you are listening. (REW ◀ ◀) You cannot rewind past the current track, even if trying to rewind from the start.
		<p>▶ : Plays the next music file.</p> <ul style="list-style-type: none"> Press and hold [▶] to fast forward music at 20-second intervals as you are listening. (FF ▶ ▶) If you fast forward to the end of the current track, the next track will start.
⏻	Button Lock	<p>Enables or disables the button lock.</p> <ul style="list-style-type: none"> If the button lock is enabled, all the buttons, except for [⏻], are disabled. Press and hold the [⏻] button to power off the projector.

Music Display Settings Menu



To open the music display settings menu, tap [] during audio playback.

MENU	DESCRIPTION
Home	Returns to the main menu page.
Play Mode	<ul style="list-style-type: none"> <All music> : Plays all music files in file name order. <Music in folder> : Plays all music files from a folder in file name order. <One music> : Plays only one selected music file.
Play Order	<p>Lets you select the playback order of music files.</p> <ul style="list-style-type: none"> <Normal> : Plays music in file name order. <Shuffle> : Plays music in random order.
Repeat	<p>Lets you select whether to repeat music.</p> <ul style="list-style-type: none"> <Off> - <On>



You can initialize or change the system settings.

General

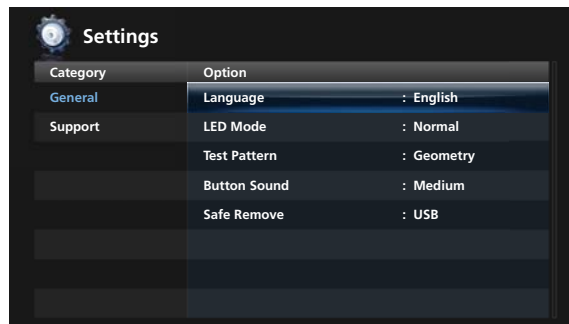

MENU	DESCRIPTION
Language	<p>Selects a system language.</p> <ul style="list-style-type: none"> <English> - <Deutsch> - <Nederlands> - <Español> - <Français> - <Italiano> - <Svenska> - <Português> - <Русский> - <Türkçe> - <ไทย> - <中国語> - <한국어>
LED Mode	<p>Set the picture brightness according to the ambient light intensity.</p> <ul style="list-style-type: none"> <Normal> - <Eco>
Test Pattern	<p>A default test pattern built into the projector. You can use it as a reference picture to optimize the location of the projector and to optimize images.</p> <ul style="list-style-type: none"> <Geometry> - <Screen Size> - <RED> - <GREEN> - <BLUE> - <WHITE>
Button Sound	<p>Selects the volume for button effects.</p> <ul style="list-style-type: none"> <Off> - <Low> - <Medium> - <High>
Safe Remove	<p>Lets you remove an external memory device (USB memory device or microSD card) safely.</p> <ul style="list-style-type: none"> <MicroSD Card> : Remove the microSD card when you see a message that reads <You can remove the MicroSD Card.> <USB> : Remove the USB device when you see a message that reads <You can remove the USB.>

Support

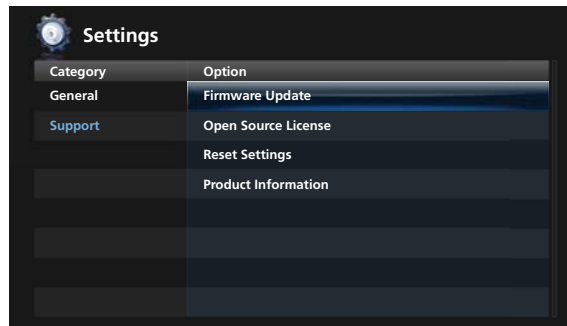

MENU	DESCRIPTION
Firmware Update	Firmware update steps: Download the firmware update from the Samsung web site, save the firmware update file to an external memory device (USB memory device), connect the device to the projector, select <Firmware Update>, and then run the file. See 3-6.
Open Source License	View Open Source License information.
Reset Settings	Return the settings customized by the user to the factory defaults.
Product Information	View <Firmware Version>, <Internal Memory>, <Copyright>, etc.

3-5 Supported File Formats

3-5-1. Document, Photo, Music

ITEM	FILE EXTENSION
Document	Adobe PDF 1.2 ~ 1.7 (pdf)
	MS PowerPoint 97 ~ 2007 (ppt, pptx)
	MS Excel (xls,xlsx)
	MS Word (doc, docx)
	Text (txt)
Photo	JPEG (A maximum of 4 mega pixels is supported for JPEG.), PNG, BMP, GIF (GIF supports neither <Rotate> nor the transition effect in <Slideshow Transition>.)
Music	MP3, MP2, WAV, WMA, FLAC, APE, HE-AAC, RA

3-5-2. Video, Subtitles

ITEM	FILE EXTENSION	CODEC	DESCRIPTION
Video	AVI	MPEG4	1280 x 720 @ 30f
	MP4	VC-1	
	ASF	H.264	1280 x 720 @ 30f / Level 4.1
	MPG	MPEG1/2	1280 x 720 @ 30f
	RM	RV	
	FLV	H.263	
	WMV	WMV7/8	480 x 272 @ 30f
	Subtitles	.smi(SAMI)	
.srt(SUBRIP)			SubRip
.sub(SUBVIEWER)			SubViewer 1.0 & 2.0

3-6 Firmware Update

Download the latest firmware version from the Samsung Electronics website (<http://www.samsung.com>) and install.

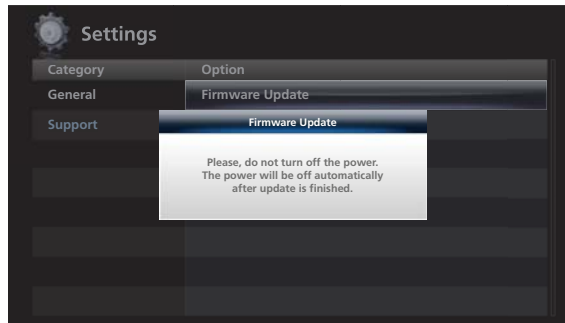

- As data saved in the internal memory can be deleted during an update, always back up your data.
- Only a USB memory device is supported for a firmware update.
- Do not remove an external (USB) memory device while an update is in progress.
- Do not operate any buttons during the update.
- Do not turn the projector off during the update.
- To confirm that the firmware has been successfully updated, go to <Settings> → <Support> → <Product Information>.

Before Firmware Update !

1. Prepare an external (USB) memory device.
2. Download the latest firmware for your projector model to your PC from the Samsung website.
3. Connect the USB memory device to the PC.
4. Copy the downloaded firmware to the USB memory device.

Updating the Firmware

1. Connect the USB memory device containing the latest firmware to the projector.
2. Select <Settings> → <Support> → <Firmware Update> in the main menu page.
3. You will see the current firmware version and the latest firmware version available.
4. Select <Update Now> to begin.
5. After the firmware is updated, the projector is automatically powered off.
6. Power on the projector and check the firmware version.

4 Troubleshooting

4-1 Before Requesting Service

🔍 Please check the following symptoms and solutions before requesting After-Sales service. If the problem continues, please contact your nearest Samsung Electronics Service Center.

	Symptoms	Troubleshooting
Installation and Connection	No Power.	<ul style="list-style-type: none">• Check the power cable connections.• Check how much power remains in the battery.
	Cannot select External Source.	<ul style="list-style-type: none">• Check if the cable to the external device is connected to the correct signal port. If not connected correctly, the projector cannot select the device.
Screen and External Source	Cannot see picture images.	<ul style="list-style-type: none">• Be sure that the power cord of the projector is connected.• Check how much power remains in the battery.• Be sure that the proper input source is selected.• Check if the connectors are properly connected to the ports at the back of the projector.
	Images are not clear.	<ul style="list-style-type: none">• Adjust the [FOCUS].• Check if the projector is too far from or too near to the screen.
	Strange noise.	<ul style="list-style-type: none">• If a strange sound continues, contact your Service Center.
	An indicator blinks.	<ul style="list-style-type: none">• Refer to the LED Indications section.
	Lines appear on screen.	<ul style="list-style-type: none">• On-screen noise may occur when using your PC. Adjust the frequency (refresh rate) of the screen.

5 More Information

5-1 Specifications

MODEL		SP-H03
Panel	Size	0.3 inches
	Resolution	WVGA (854 x 480)
Aspect ratio		16 : 9
Power	Power Consumption	Max 12.0W (Operating & Charging at Adapter), TYP. 8.5W (Operating at Battery)
	Power Supply (Adapter)	This product supports 100 – 240 V. Since the standard voltage may differ from country to country, please check the label on the back of the product. (DC 12 V  1.0 A)
LED Light Source	Power Consumption	4 W
	Life Time	30,000 Hours
Dimension (Width x Length x Height)		70 x 70 x 27.5 mm / 2.76 x 2.76 x 1.08 inches (without the battery) 70 x 70 x 37.5 mm / 2.76 x 2.76 x 1.48 inches (with the battery)
Weight		Projector : 132 g / 0.29 lbs Battery : 80 g / 0.18 lbs
Key Features	Brightness	TYP 27, MAX 30 Lumen
	Contrast	1000 : 1
	Projection Range	30.5 ~ 299 cm / 12.00 ~ 117.71 inches
	Keystone	< 1%
	Focus Adjustment	Manual
	Screen Size (Diagonal)	Diagonal 8.6 inches ~ 85.5 inches
Input signal	D-Sub 15p	Analog RGB
	Media Play	USB, internal memory and MicroSD
	RCA x 1	Composite video
Internal memory capacity		1 GB (System memory: 301 MB / User memory: 699 MB)
Speaker		1 W (Mono)
User Environment	Temperature and Humidity	Operating : Temperature 32 °F ~ 104 °F (0 °C ~ 40 °C), Humidity 10 % ~ 80 % (Non-condensing)
		Storage : Temperature -4 °F ~ 113 °F (-20 °C ~ 45 °C), Humidity 5 % ~ 95 % (Non-condensing)
Noise		23 dB

 Class B (Information Communication equipment for residential use)

This device is registered for EMC requirements for home use (Class B). It can be used in all areas. (Class B equipment emits less electromagnetic waves than Class A equipment.)

❏ The DMD panel used for the PICO projector consists of hundreds of thousands of tiny mirrors. Just like many other types of image displays, the DMD panel may include bad pixels. The criteria for distinguishing bad pixels and the maximum quantity of bad pixels allowed for the DMD panel are strictly controlled by our company and the manufacturer of the DMD panel before shipment according to the predefined specifications. Though some pixels may not be visible in the screen, this neither affects the picture quality significantly, nor the lifespan of the projector.

[U.S. Only]

Dispose unwanted electronics through an approved recycler.
To find the nearest recycling location, go to our website,
www.samsung.com/recyclingdirect, or call (877) 278 - 0799

5-2 Contact SAMSUNG WORLDWIDE

 If you have any questions or comments relating to Samsung products, please contact the SAMSUNG customer care center.

NORTH AMERICA		
CANADA	1-800-SAMSUNG (726-7864)	http://www.samsung.com
MEXICO	01-800-SAMSUNG (726-7864)	http://www.samsung.com
U.S.A	1-800-SAMSUNG (726-7864)	http://www.samsung.com
LATIN AMERICA		
ARGENTINA	0800-333-3733	http://www.samsung.com
BRAZIL	0800-124-421 4004-0000	http://www.samsung.com
CHILE	800-SAMSUNG (726-7864)	http://www.samsung.com
COLOMBIA	01-8000112112	http://www.samsung.com
COSTA RICA	0-800-507-7267	http://www.samsung.com
DOMINICA	1-800-751-2676	http://www.samsung.com
ECUADOR	1-800-10-7267	http://www.samsung.com
EL SALVADOR	800-6225	http://www.samsung.com
GUATEMALA	1-800-299-0013	http://www.samsung.com
HONDURAS	800-27919267	http://www.samsung.com
JAMAICA	1-800-234-7267	http://www.samsung.com
NICARAGUA	00-1800-5077267	http://www.samsung.com
PANAMA	800-7267	http://www.samsung.com
PERU	0-800-777-08	http://www.samsung.com
PUERTO RICO	1-800-682-3180	http://www.samsung.com
TRINIDAD & TOBAGO	1-800-SAMSUNG (726-7864)	http://www.samsung.com
VENEZUELA	0-800-100-5303	http://www.samsung.com
EUROPE		
ALBANIA	42 27 5755	-
AUSTRIA	0810 - SAMSUNG (7267864, € 0.07/min)	http://www.samsung.com
BELGIUM	02-201-24-18	http://www.samsung.com/be (Dutch) http://www.samsung.com/be_fr (French)
BOSNIA	05 133 1999	-
BULGARIA	07001 33 11	http://www.samsung.com
CROATIA	062 SAMSUNG (062 726 7864)	http://www.samsung.com
CZECH	800 - SAMSUNG (800-726786)	http://www.samsung.com
	Samsung Zrt., česká organizační složka, Oasis Florenc, Sokolovská394/17, 180 00, Praha 8	
DENMARK	70 70 19 70	http://www.samsung.com
FINLAND	030 - 6227 515	http://www.samsung.com

EUROPE		
FRANCE	01 48 63 00 00	http://www.samsung.com
GERMANY	01805 - SAMSUNG (726-7864,€ 0,14/Min)	http://www.samsung.com
GREECE	2106293100	http://www.samsung.com
HUNGARY	06-80-SAMSUNG (726-7864)	http://www.samsung.com
ITALIA	800-SAMSUNG (726-7864)	http://www.samsung.com
KOSOVO	+381 0113216899	-
LUXEMBURG	261 03 710	http://www.samsung.com
MACEDONIA	023 207 777	-
MONTENEGRO	020 405 888	-
NETHERLANDS	0900 - SAMSUNG (0900-7267864) (€ 0,10/Min)	http://www.samsung.com
NORWAY	815-56 480	http://www.samsung.com
POLAND	0 801 1SAMSUNG (172678) 022 - 607 - 93 - 33	http://www.samsung.com
PORTUGAL	80820 - SAMSUNG (726-7864)	http://www.samsung.com
RUMANIA	08010 SAMSUNG (08010 7267864) – doar din rețeaua Romtelecom, tarif local; 021.206.01.10 – din orice rețea, tarif normal	http://www.samsung.com
SERBIA	0700 Samsung (0700 726 7864)	http://www.samsung.com
SLOVAKIA	0800 - SAMSUNG(0800-726 786)	http://www.samsung.com/sk
SPAIN	902 - 1 - SAMSUNG (902 172 678)	http://www.samsung.com
SWEDEN	0771 726 7864 (SAMSUNG)	http://www.samsung.com
SWITZERLAND	0848-SAMSUNG (7267864, CHF 0.08/min)	http://www.samsung.com/ch http://www.samsung.com/ch_fr (French)
U.K	0330 SAMSUNG (7267864)	http://www.samsung.com
EIRE	0818 717100	http://www.samsung.com
LITHUANIA	8-800-77777	http://www.samsung.com
LATVIA	8000-7267	http://www.samsung.com
ESTONIA	800-7267	http://www.samsung.com
TURKEY	444 77 11	http://www.samsung.com
CIS		
RUSSIA	8-800-555-55-55	http://www.samsung.com
GEORGIA	8-800-555-555	-
ARMENIA	0-800-05-555	-
AZERBAIJAN	088-55-55-555	-
KAZAKHSTAN	8-10-800-500-55-500 (GSM: 7799)	http://www.samsung.com
UZBEKISTAN	8-10-800-500-55-500	http://www.samsung.com
KYRGYZSTAN	00-800-500-55-500	http://www.samsung.com

CIS		
TADJIKISTAN	8-10-800-500-55-500	http://www.samsung.com
UKRAINE	0-800-502-000	http://www.samsung.com/ua http://www.samsung.com/ua_ru
BELARUS	810-800-500-55-500	-
MOLDOVA	00-800-500-55-500	-
ASIA PACIFIC		
AUSTRALIA	1300 362 603	http://www.samsung.com
NEW ZEALAND	0800 SAMSUNG (0800 726 786)	http://www.samsung.com
CHINA	400-810-5858	http://www.samsung.com
HONG KONG	(852) 3698 - 4698	http://www.samsung.com/hk http://www.samsung.com/hk_en/
INDIA	3030 8282, 1800 3000 8282	http://www.samsung.com
INDONESIA	0800-112-8888 021-5699-7777	http://www.samsung.com
JAPAN	0120-327-527	http://www.samsung.com
MALAYSIA	1800-88-9999	http://www.samsung.com
PHILIPPINES	1-800-10-SAMSUNG (726-7864) 1-800-3-SAMSUNG (726-7864) 1-800-8-SAMSUNG (726-7864) 02-5805777	http://www.samsung.com
SINGAPORE	1800-SAMSUNG (726-7864)	http://www.samsung.com
THAILAND	1800-29-3232 02-689-3232	http://www.samsung.com
TAIWAN	0800-329-999	http://www.samsung.com
VIETNAM	1 800 588 889	http://www.samsung.com
MIDDLE EAST		
IRAN	021-8255	http://www.samsung.com http://www.samservice.com
OMAN	800-SAMSUNG (726-7864)	http://www.samsung.com
KUWAIT	183-2255	http://www.samsung.com
BAHRAIN	8000-4726	http://www.samsung.com
EGYPT	08000-726786	http://www.samsung.com
JORDAN	800-22273	http://www.samsung.com
MOROCCO	080 100 2255	http://www.samsung.com
SAUDI ARABIA	9200-21230	http://www.samsung.com
U.A.E	800-SAMSUNG (726-7864)	http://www.samsung.com

AFRICA

NIGERIA	0800 - SAMSUNG (726-7864)	http://www.samsung.com
SOUTH AFRICA	0860-SAMSUNG (726-7864)	http://www.samsung.com

Correct Disposal of This Product (Waste Electrical & Electronic Equipment) - Europe only



(Applicable in the European Union and other European countries with separate collection systems)

This marking on the product, accessories or literature indicates that the product and its electronic accessories (e.g. charger, headset, USB cable) should not be disposed of with other household waste at the end of their working life. To prevent possible harm to the environment or human health from uncontrolled waste disposal, please separate these items from other types of waste and recycle them responsibly to promote the sustainable reuse of material resources.

Household users should contact either the retailer where they purchased this product, or their local government office, for details of where and how they can take these items for environmentally safe recycling.

Business users should contact their supplier and check the terms and conditions of the purchase contract. This product and its electronic accessories should not be mixed with other commercial wastes for disposal.

**The rechargeable battery incorporated in this product is not user replaceable.
For information on its replacement, please contact your service provider.**